

# VIA-PA 600W 2.5

НПО-СЭП / +7 (343) 300-95-43 / info@sep-npo.ru

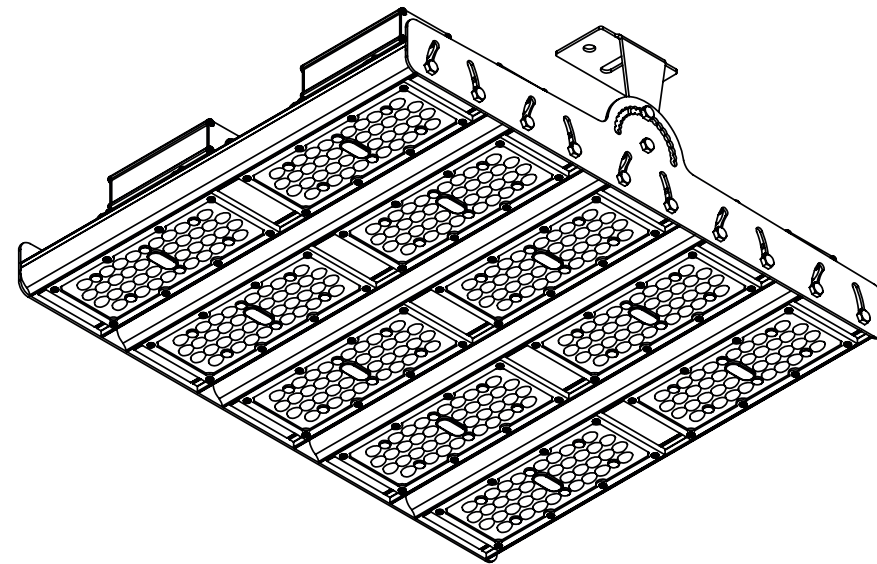

НА САЙТЕ

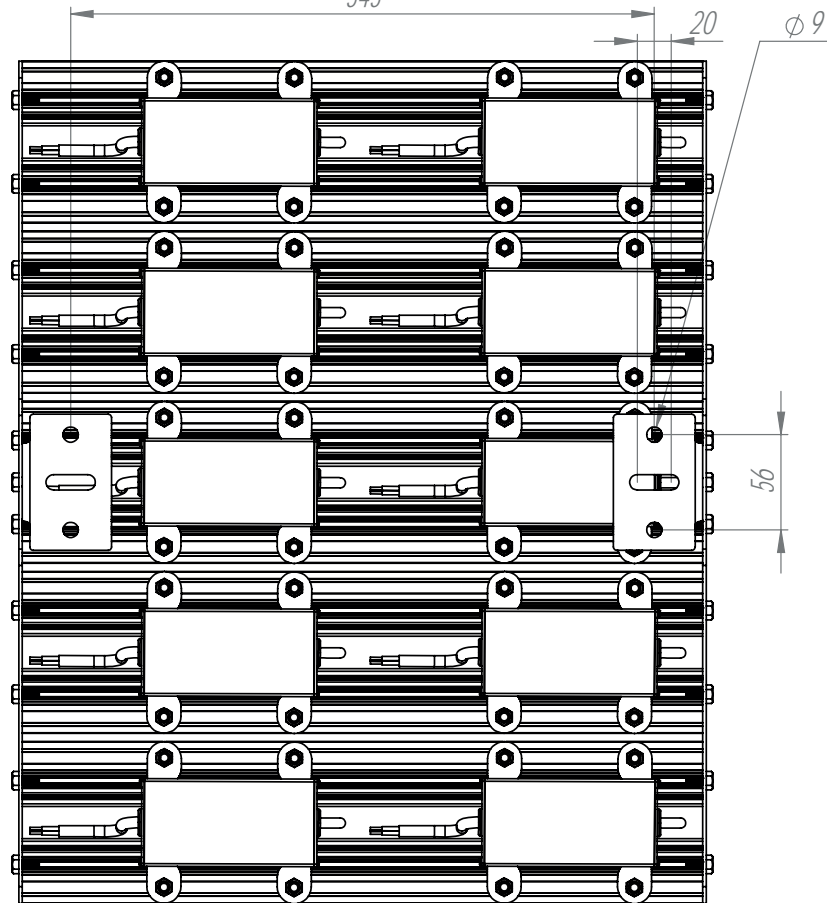
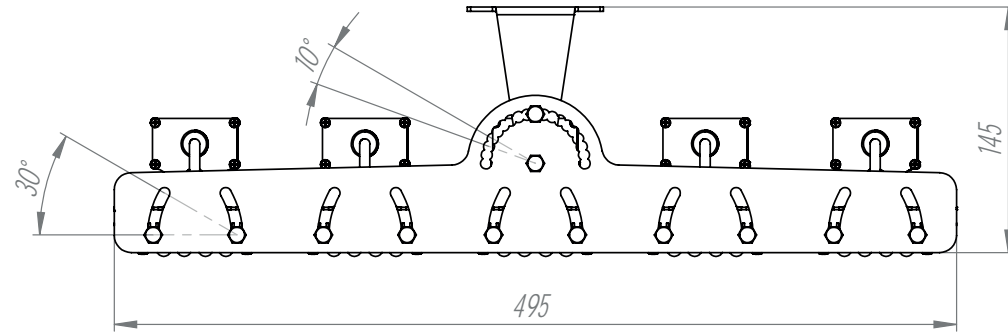
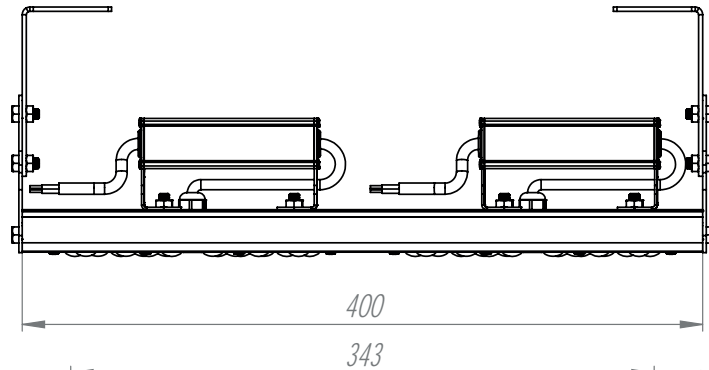